

# Sealing insert / Grommet

18-3

Item number: BG18-3-E

## Mechanical properties

Size: 18

## Thermal properties

Material contact insert: Ethylene acrylate GXF / thermoplastic

Operating temperature: -55°C - +150°C

Fire protection class DIN EN 45545-2: R23/HL3

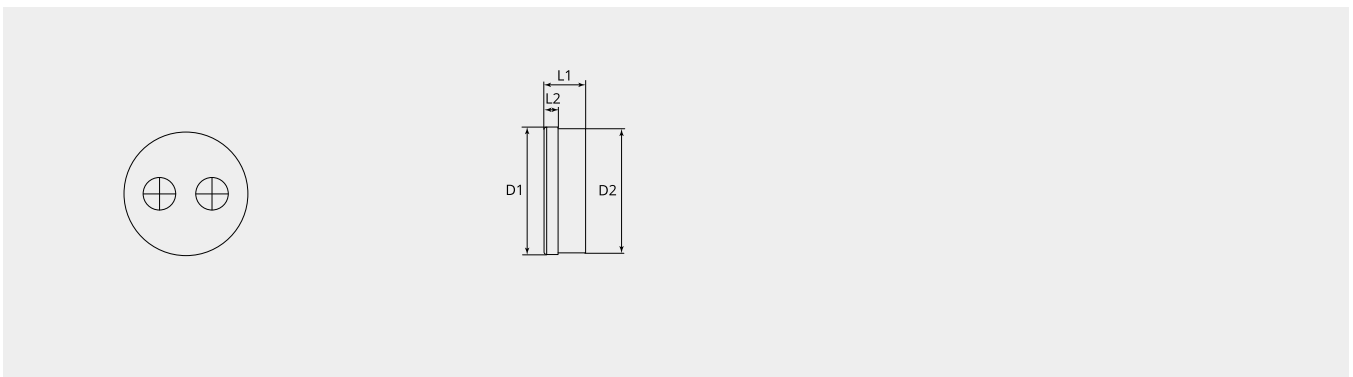

## Dimensional drawing

D1 (Ø): 21.0

D2 (Ø): 18.9

L1 (mm): 13.2

L2 (mm): 2.4

Grommets are sitting inside the backshells. The applied compression ring compresses the grommet during tightening the backshell to the plug/receptacle. The grommet deforms and seals and support the installed wires accordingly. The compression ring also avoid increasing friction (gliding ring) if tightening the backshell onto the plug/receptacle that may cause distortion of the elastomeric grommet.