



Sealing insert / Grommet

22-22

Item number: BG22-22-E

Mechanical properties

Size: 22

Thermal properties

Material contact insert: Ethylene acrylate GXF / thermoplastic

Operating temperature: -55°C - +150°C

Fire protection class DIN EN 45545-2: R23/HL3

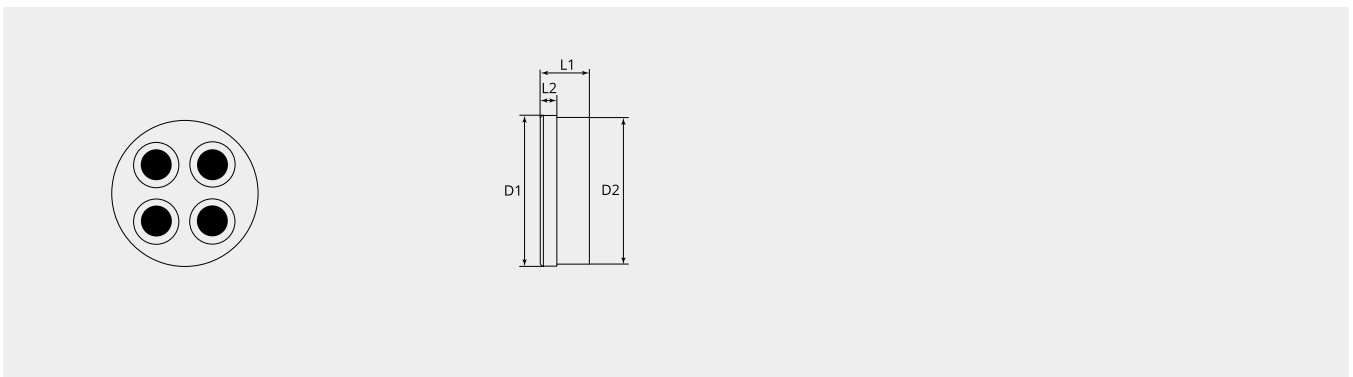

Dimensional drawing

D1 (Ø): 27.6

D2 (Ø): 25.3

L1 (mm): 13.3

L2 (mm): 2.4

Grommets are sitting inside the backshells. The applied compression ring compresses the grommet during tightening the backshell to the plug/receptacle. The grommet deforms and seals and support the installed wires accordingly. The compression ring also avoid increasing friction (gliding ring) if tightening the backshell onto the plug/receptacle that may cause distortion of the elastomeric grommet.

For 90° elbow backshells, no compression rings are needed.