



Sealing insert / Grommet

28-12

Item number: BG28-12-E

Net weight: 0.0151 kg

Mechanical properties

Size: 28

Thermal properties

Material contact insert: Ethylene acrylate GXF / thermoplastic

Operating temperature: -55°C - +150°C

Fire protection class DIN EN 45545-2: R23/HL3

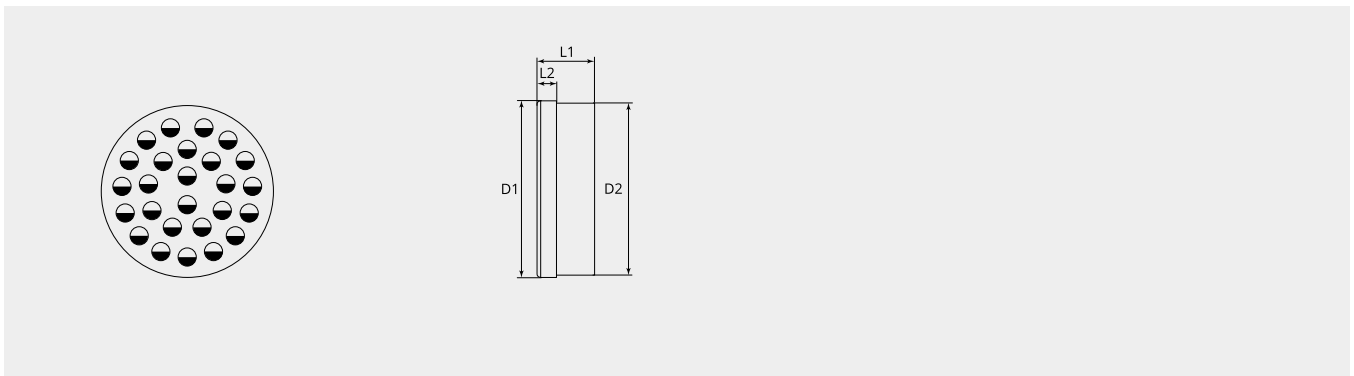

Dimensional drawing

D1 (Ø): 35.0

D2 (Ø): 33.0

L1 (mm): 13.5

L2 (mm): 2.5

Grommets are sitting inside the backshells. The applied compression ring compresses the grommet during tightening the backshell to the plug/receptacle. The grommet deforms and seals and support the installed wires accordingly. The compression ring also avoid increasing friction (gliding ring) if tightening the backshell onto the plug/receptacle that may cause distortion of the elastomeric grommet.

For 90° elbow backshells, no compression rings are needed.