



# Heatshrinkable shape, straight, with adhesive

Free of halogene, chemically cross linked, flexible

Item number: FTH08-04

Packing unit: 1

## Mechanical properties

Material:	Polyolefin, cross-linked (PO-X)
Adhesive:	Modified polyamide hot melt adhesive
Surface colour:	black

## Thermal properties

Fire protection class:	VG95343
------------------------	---------

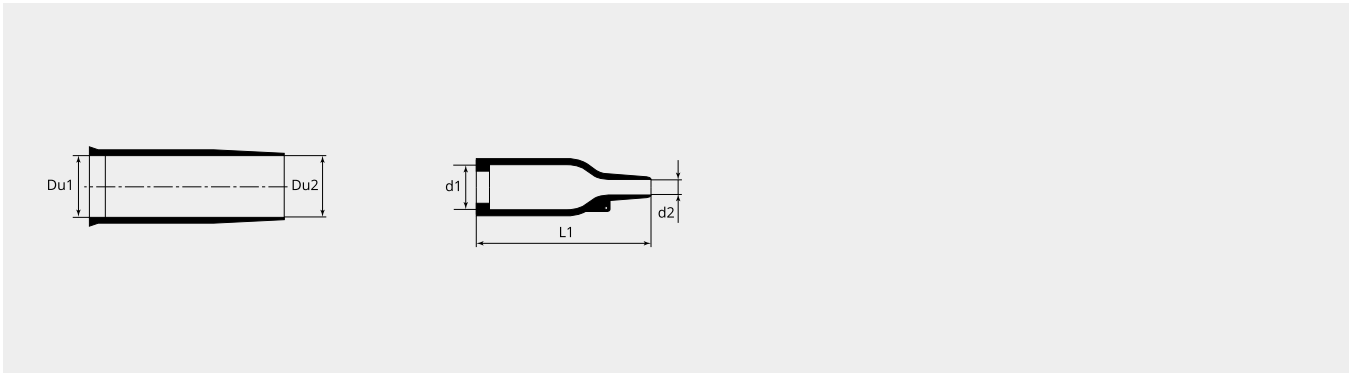

## Dimensional drawing

Du1 (mm):	16.0
Du2 (mm):	16.0
d1 (Ø):	8.0
d2 (Ø):	4.0
L1 (mm):	26.0