



Plug with bayonet coupling nut

Series GB

Item number: GB60-32-013SN-EAC

Net weight: 0.1295 kg

Mechanical properties

| | |
|---------------------------------|--------------------|
| Size: | 32 |
| Contact type: | Socket |
| Coding options: | 4 |
| Number of contacts, size 12: | 13 |
| Shell material: | Aluminum alloy |
| Surface treatment: | Epoxy-polyurethane |
| Type of surface: | varnished |
| Thickness of surface treatment: | 13-16 μ |
| Surface colour: | black |
| Corrosion resistance (h): | 500 |
| Operation temperature: | -55°C - +125°C |
| Temperature shock: | -55°C - +125°C |
| Conductivity (M Ω): | non conductive |
| EMI: | No |
| Material sealing ring: | Silicone |
| Coupling-torque to lock (Nm): | max. 8.0 |
| Coupling-torque to open (Nm): | min. 3.6 |

Thermal properties

| | |
|---------------------------------------|---------------------------------------|
| Material contact insert: | Ethylene acrylate GXF / thermoplastic |
| Operating temperature: | -55°C - +150°C |
| Fire protection class DIN EN 45545-2: | R23/HL3 |

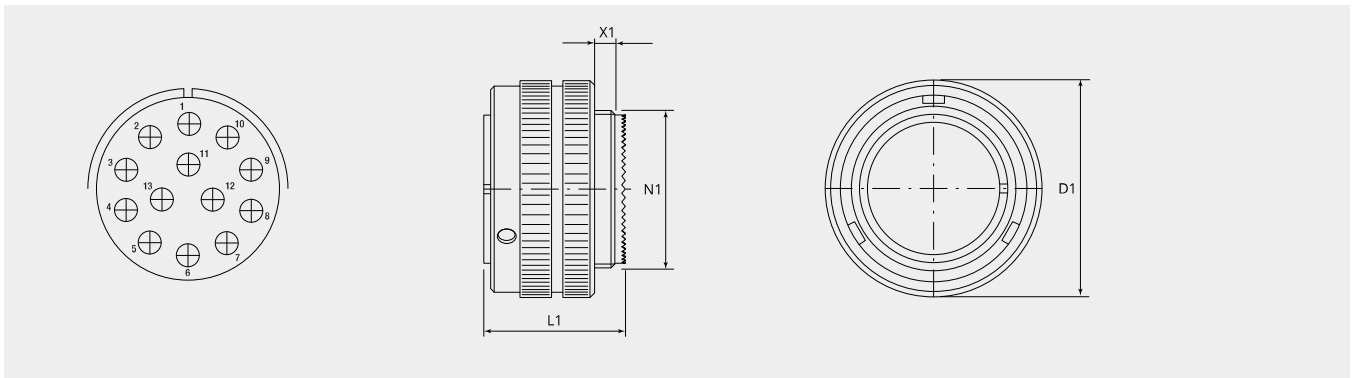

Dimensional drawing

| | |
|-----------------|-----------------|
| D1 (Ø): | 60.0 |
| L1 (mm): | 38 |
| N1: | 1 7/8"-16 UN 2A |
| X1 (mm): | 10.5 |

Electrical properties

| | |
|---|---------------|
| Operating voltage AC (V): | 250/450* |
| Voltage class: | SEV-EN60998-1 |
| Contact numbers: | All |
| Operating voltage DC (V): | 1250 |
| Operating voltage AC (V): | 900 |
| Test voltage AC (V): | 2800 |
| Insulation resistance (Ω m): | ≥ 5000 |
| Insulation creepage distance (mm): | ≥ 4.8 |
| Voltage class: | MIL-DTL-5015 |

Electrical properties contacts

| | |
|---------------------------------------|----|
| Size 12 - nominal current (A): | 23 |
| Size 12 - maximal current (A): | 41 |
| Size 12 - test current (A): | 35 |

Complementary products:

Counterpart:



GB210-32-013PN-EAC
Receptacle, front panel mount

Backshell:

BEN32-AC
90° elbow back shell



BEN32-M6B-AC
90° elbow back shell with internal metric thread



BSE32-36-AC
Enlarger back shell



BSH32-AC
Back shell with groove for heatshrinkable shapes



BSL32-AC
Back shell straight, long

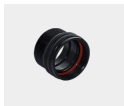

BSN32-AC
Back shell straight, standard



BSN32-M6B-AC
Back shell straight with internal metric thread



BSR32-18-AC
Reducer back shell



BST32-AC
Termination back shell type R for grommets

Cable termination:

10-350349K-323
Synthetic cable clamp

Contacts:



10-40560-11AU

Socket contact size 12, 0.5mm²



10-40560-15AU

Socket contact size 12, 0.75 - 1.0mm²

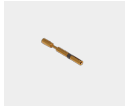

10-40560-18AU

Socket contact size 12, 1.5mm²

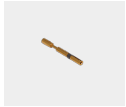

10-40560-22AU

Socket contact size 12, 2.5mm²

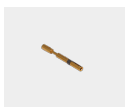

10-40560-30AU

Socket contact size 12, 4.0mm²

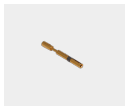

10-40560-38AU

Socket contact size 12, 6.0mm²

Filler plugs:

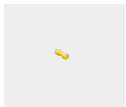

10-101033-131

Filler plug, size 12

Protection cap:



PP32-AC

Metallic protection cap to bayonet plug (GB,GR & GS)



PP32-D

Plastic protection cap to bayonet plugs (GB, GR & GS)