



Plug with rubber coated coupling nut, short version

Series GB

Item number: GB603-32-013SN-EAC

Mechanical properties

Size:	32
Contact type:	Socket
Coding options:	4
Number of contacts, size 12:	13
Shell material:	Aluminum alloy
Surface treatment:	Epoxy-polyurethane
Type of surface:	varnished
Thickness of surface treatment:	13-16 μ
Surface colour:	black
Corrosion resistance (h):	500
Operation temperature:	-55°C - +125°C
Temperature shock:	-55°C - +125°C
Conductivity (M Ω):	non conductive
EMI:	No
Material sealing ring:	Silicone
Coupling-torque to lock (Nm):	max. 8.0
Coupling-torque to open (Nm):	min. 3.6

Thermal properties

Material contact insert:	Ethylene acrylate GXF / thermoplastic
Operating temperature:	-55°C - +150°C
Fire protection class DIN EN 45545-2:	R23/HL3

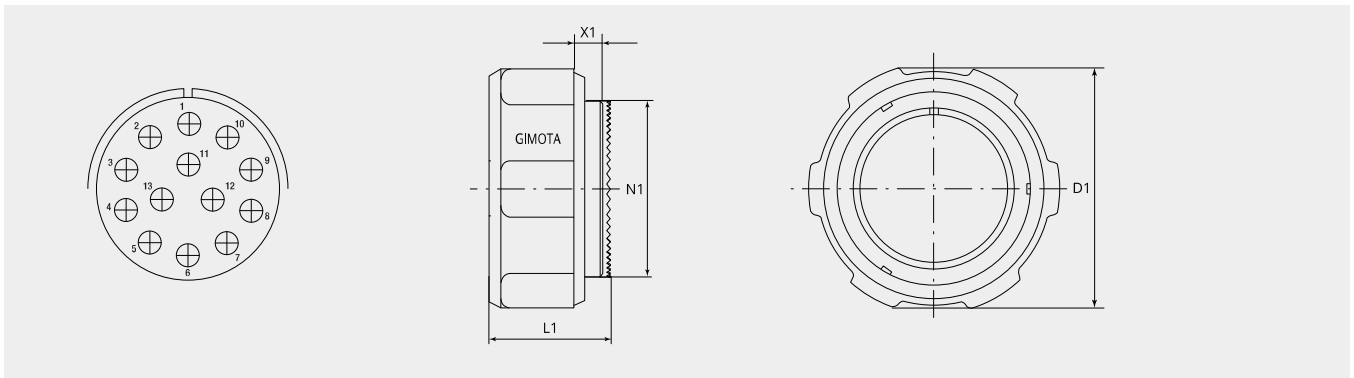

Dimensional drawing

D1 (Ø):	76.0
L1 (mm):	38
N1:	1 7/8"-16 UN 2A
X1 (mm):	10.5

Electrical properties

Operating voltage AC (V):	250/450*
Insulation resistance (Ω m):	≥ 5000
Voltage class:	SEV-EN60998-1
Contact numbers:	All
Operating voltage DC (V):	1250
Operating voltage AC (V):	900
Test voltage AC (V):	2800
Insulation resistance (Ω m):	≥ 5000
Insulation creepage distance (mm):	≥ 4.8
Voltage class:	MIL-DTL-5015

Electrical properties contacts

Size 12 - nominal current (A):	23
Size 12 - maximal current (A):	41
Size 12 - test current (A):	35

Complementary products:

Counterpart:



GB210-32-013PN-EAC
Receptacle, front panel mount

Backshell:



BEN32-AC
90° elbow back shell



BEN32-M6B-AC
90° elbow back shell with internal metric thread



BSE32-36-AC
Enlarger back shell



BSH32-AC
Back shell with groove for heatshrinkable shapes



BSL32-AC
Back shell straight, long

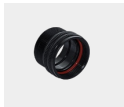

BSN32-AC
Back shell straight, standard



BSN32-M6B-AC
Back shell straight with internal metric thread



BSR32-18-AC
Reducer back shell

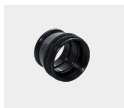

BST32-AC
Termination back shell type R for grommets

Cable termination:



10-350349K-323
Synthetic cable clamp

Contacts:

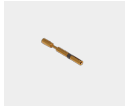
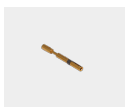
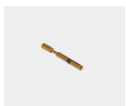
**10-40560-11AU**Socket contact size 12, 0.5mm²**10-40560-15AU**Socket contact size 12, 0.75 - 1.0mm²**10-40560-18AU**Socket contact size 12, 1.5mm²**10-40560-22AU**Socket contact size 12, 2.5mm²**10-40560-30AU**Socket contact size 12, 4.0mm²**10-40560-38AU**Socket contact size 12, 6.0mm²

Filler plugs:

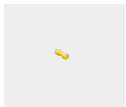
**10-101033-131**

Filler plug, size 12

Protection cap:

**PP32-AC**

Metallic protection cap to bayonet plug (GB, GR & GS)

**PP32-D**

Plastic protection cap to bayonet plugs (GB, GR & GS)