



Cable receptacle

Series GS

Item number: GS11-32-A9PN-EAA

Packing unit: 1

Mechanical properties

Size:	32
Contact type:	Pin
Coding options:	4
Number of contacts, size 16:	6
Number of contacts, size 4:	3
Shell material:	Aluminum alloy
Surface treatment:	Zinc
Type of surface:	passivated
Thickness of surface treatment:	12-15 μ
Surface colour:	black
Corrosion resistance (h):	200
Operation temperature:	-55°C - +90°C
Temperature shock:	-55°C - +125°C
Conductivity (M Ω):	\leq 0.5
EMI:	Yes
Coupling-torque to lock (Nm):	max. 8.0
Coupling-torque to open (Nm):	min. 3.6

Thermal properties

Material contact insert:	Ethylene acrylate GXF
Operating temperature:	-55°C - +150°C
Fire protection class DIN EN 45545-2:	R23/HL3

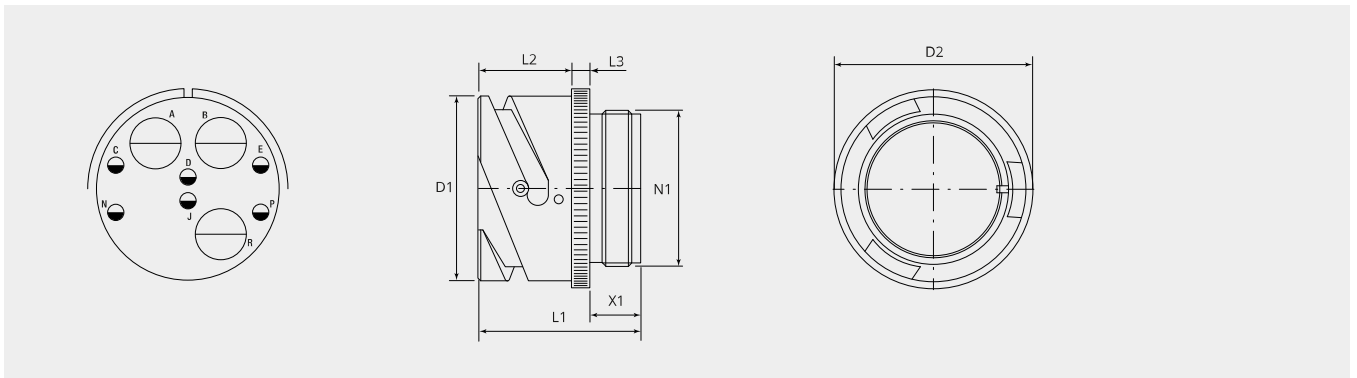

Dimensional drawing

D1 (Ø):	53.5
D2 (Ø):	56.0
L1 (mm):	37.5
L2 (mm):	22.0
L3 (mm):	4.0
N1:	1 7/8"-16 UN 2A
X1 (mm):	10.5

Electrical properties

Operating voltage DC (V):	700
Operating voltage AC (V):	500
Test voltage AC (V):	2000
Insulation resistance (Ω m):	≥ 5000
Insulation creepage distance (mm):	≥ 3.2
Voltage class:	MIL-DTL-5015

Electrical properties contacts

Size 4 - nominal current (A):	80
Size 4 - maximal current (A):	135
Size 4 - test current (A):	110
Size 16 - nominal current [continuous] (A):	13
Size 16 - maximal current [short-term] (A):	22
Size 16 - test current (A):	20

Please contact your Gimota partner for other shell materials, surface coatings or contact insert materials.

Voltage classes tested acc. MIL-DTL-5015

Power transmission verification acc. VG95234 / 2 test 5.10.1 and VG95210 / 37

Corrosion resistance tested acc. MIL 1344A Test 101.1

Temperature shock tested acc. MIL 202F, 107G Method

Electrical conductivity acc. MIL 1344A, Test 3007

Complementary products:

Counterpart:



GS60-32-A9SN-EAA

Plug with bayonet coupling nut



GS601-32-A9SN-EAA

Plug with bayonet coupling nut, for EMI applications



GS602-32-A9SN-EAA

Plug with rubber coated coupling nut



GS604-32-A9SN-EAA

Plug with rubber coated coupling nut, for EMI applications

Backshell:

BEN32-AA
90° elbow backshell



BEN32-M6B-AA
90° elbow backshell with internal metric thread



BSE32-36-AA
Enlarger back shell



BSH32-AA
Backshell with groove for heatshrinkable shapes



BSL32-AA
Backshell straight, long

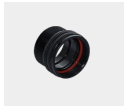

BSN32-AA
Backshell straight, standard



BSN32-M6B-AA
Backshell straight with internal metric thread



BSR32-18-AA
Reducer backshell



BST32-AA
Termination back shell typ R for grommet



ET-32-10-AA
EMI adapter with cone ring, for heatshrinkable shape

Cable termination:

10-350349K-323
Synthetic cable clamp

Contacts:

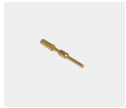
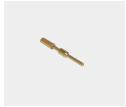
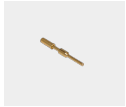
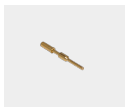
**10-40561-11AU**Pin contact size 12, 0.5mm²**10-40561-15AU**Pin contact size 12, 0.75 - 1.0mm²**10-40561-18AU**Pin contact size 12, 1.5mm²**10-40561-22AU**Pin contact size 12, 2.5mm²**10-40561-30AU**Pin contact size 12, 4.0mm²**10-40561-38AU**Pin contact size 12, 6.0mm²**10-660-4-10G10**Pin contact size 4, 10mm²**10-660-4-16G10**Pin contact size 4, 16mm²**10-660-4-16G62**Pin contact size 4, 16mm²**10-660-4-6G10**Pin contact size 4, 6.0mm²

Filler plugs:

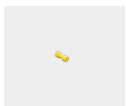
**10-101033-131**

Filler plug, size 12

**10-101033-4**

Filler plug, size 4

Protection cap:



PR32-AA

Metallic protection cap for bayonet receptacles (GB,GR & GS)



PR32-D

Plastic protection cap to bayonet receptacles (GB, GR &GS)