



Plug with rubber coated coupling nut, for EMI applications

Series GS

Item number: GS604-24-A28PN-EAA

Packing unit: 1

Mechanical properties

Size:	28
Contact type:	Pin
Coding options:	3
Number of contacts, size 16:	28
Shell material:	Aluminum alloy
Surface treatment:	Zinc
Type of surface:	passivated
Thickness of surface treatment:	12-15 μ
Surface colour:	black
Corrosion resistance (h):	200
Operation temperature:	-55°C - +90°C
Temperature shock:	-55°C - +125°C
Conductivity (M Ω):	\leq 0.5
EMI:	Yes
Coupling-torque to lock (Nm):	max. 7.0
Coupling-torque to open (Nm):	min. 2.7

Thermal properties

Material contact insert:	Ethylene acrylate GXF
Operating temperature:	-55°C - +150°C
Fire protection class DIN EN 45545-2:	R23/HL3

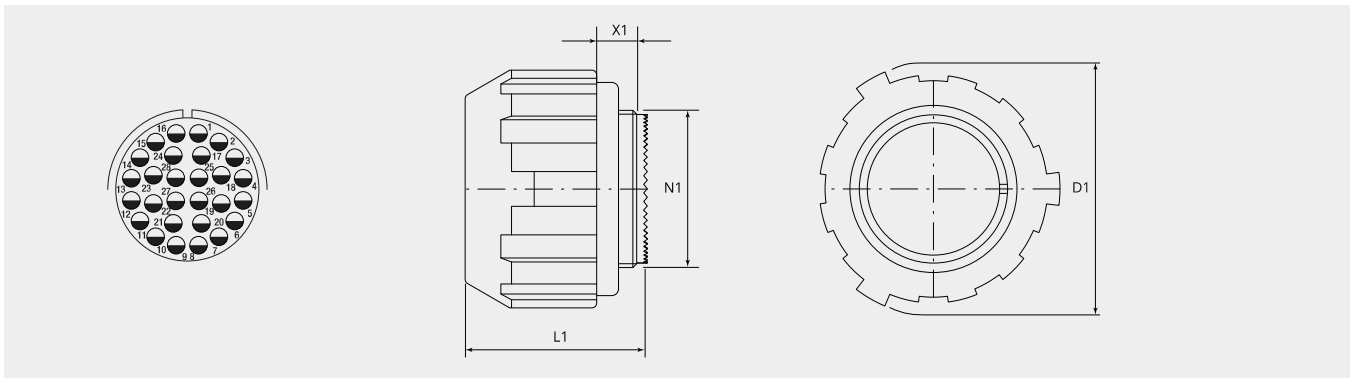

Dimensional drawing

D1 (Ø):	67.0
L1 (mm):	39.0
N1:	1 5/8"-18 UNEF 2A
X1 (mm):	9.0

Electrical properties

Operating voltage DC (V):	250
Operating voltage AC (V):	200
Test voltage AC (V):	1000
Insulation resistance (Ω m):	≥ 5000
Insulation creepage distance (mm):	≥ 1.6
Voltage class:	MIL-DTL-5015

Electrical properties contacts

Size 16 - nominal current [continuous] (A):	13
Size 16 - maximal current [short-term] (A):	22
Size 16 - test current (A):	20

Please contact your Gimota partner for other shell materials, surface coatings or contact insert materials.

Voltage classes tested acc. MIL-DTL-5015

Power transmission verification acc. VG95234 / 2 test 5.10.1 and VG95210 / 37

Corrosion resistance tested acc. MIL 1344A Test 101.1

Temperature shock tested acc. MIL 202F, 107G Method

Electrical conductivity acc. MIL 1344A, Test 3007