



Jam nut receptacle

Series GS

Item number: GS72-24-07PN-EAA

Packing unit: 1

Mechanical properties

Size:	24
Contact type:	Pin
Coding options:	2
Number of contacts, size 12:	7
Shell material:	Aluminum alloy
Surface treatment:	Zinc
Type of surface:	passivated
Thickness of surface treatment:	12-15 μ
Surface colour:	black
Corrosion resistance (h):	200
Operation temperature:	-55°C - +90°C
Temperature shock:	-55°C - +125°C
Conductivity (M Ω):	\leq 0.5
EMI:	Yes
Coupling-torque to lock (Nm):	max. 6.5
Coupling-torque to open (Nm):	min. 2.0

Thermal properties

Material contact insert:	Ethylene acrylate GXF
Operating temperature:	-55°C - +150°C
Fire protection class DIN EN 45545-2:	R23/HL3

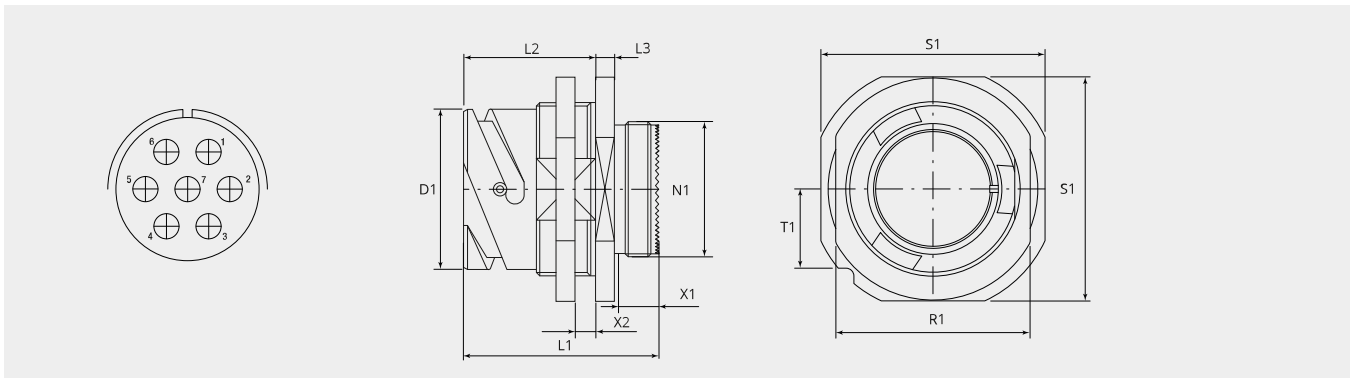

Dimensional drawing

D1 (Ø):	41.0
L1 (mm):	50.5
L2 (mm):	33.7
L3 (mm):	4.8
N1:	1 3/8"-18 UNEF 2A
T1 (mm):	20.2
X1 (mm):	9.0
X2 (mm):	2.4 - 9.1
S1 (mm):	57.2
R1 (mm):	50.8

Electrical properties

Operating voltage AC (V):	130/250*
Voltage class:	SEV-EN60998-1
Contact numbers:	All
Operating voltage DC (V):	1250
Operating voltage AC (V):	900
Test voltage AC (V):	2800
Insulation resistance (Ω m):	≥ 5000
Insulation creepage distance (mm):	≥ 4.8
Voltage class:	MIL-DTL-5015

Electrical properties contacts

Size 12 - nominal current (A):	23
Size 12 - maximal current (A):	41
Size 12 - test current (A):	35

Please contact your Gimota partner for other shell materials, surface coatings or contact insert materials.

Voltage classes tested acc. MIL-DTL-5015

Power transmission verification acc. VG95234 / 2 test 5.10.1 and VG95210 / 37

Corrosion resistance tested acc. MIL 1344A Test 101.1

Temperature shock tested acc. MIL 202F, 107G Method

Electrical conductivity acc. MIL 1344A, Test 3007

Complementary products:

Counterpart:



GS60-24-07SN-EAA

Plug with bayonet coupling nut



GS601-24-07SN-EAA

Plug with bayonet coupling nut, for EMI applications



GS602-24-07SN-EAA

Plug with rubber coated coupling nut



GS604-24-07SN-EAA

Plug with rubber coated coupling nut, for EMI applications

Backshell:



BEN24-AA
90° elbow backshell



BEN24-M5B-AA
90° elbow backshell with internal metric thread



BSH24-AA
Backshell with groove for heatshrinkable shapes



BSL24-AA
Backshell straight, long



BSN24-M5B-AA
Backshell straight with internal metric thread



BSR24-18-AA
Reducer backshell

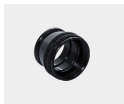

BST24-AA
Termination back shell typ R for grommet



ET-24-07-AA
EMI adapter with cone ring, for heatshrinkable shape

Cable termination:



10-350349K-2432
Synthetic cable clamp

Contacts:

**10-40561-11AU**

Pin contact size 12, 0.5mm²

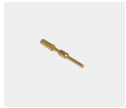
**10-40561-15AU**

Pin contact size 12, 0.75 - 1.0mm²

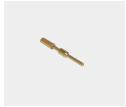
**10-40561-18AU**

Pin contact size 12, 1.5mm²

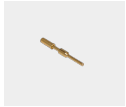
**10-40561-22AU**

Pin contact size 12, 2.5mm²

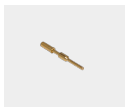
**10-40561-30AU**

Pin contact size 12, 4.0mm²

**10-40561-38AU**

Pin contact size 12, 6.0mm²

Filler plugs:

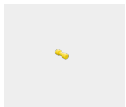
**10-101033-131**

Filler plug, size 12

Protection cap:

**PR24-AA**

Metallic protection cap for bayonet receptacles (GB, GR & GS)

**PR24-D**

Plastic protection cap to bayonet receptacles (GB, GR & GS)