



# Pin contact housing D-SUB - 2-poles

Item number: SUH02W2P

## Technical characteristics

Size:	1
Shell material:	Steel
Surface treatment:	Tin plated
Material contact insert:	Thermoplastic
Operation temperature:	-55°C - +105°C
Fire protection class UL94:	UL94 - V0

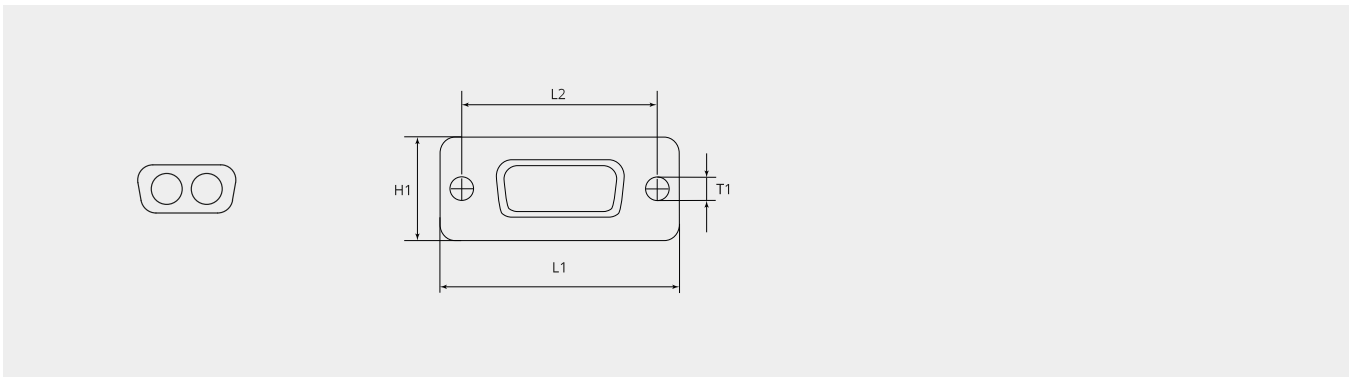

## Dimensional drawing

L1 (mm):	30.8
L2 (mm):	25.0
T1 (mm):	3.0
H1 (mm):	12.5

## Complementary products:

**Contacts:**

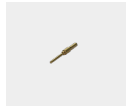

**SUMCP18-22AU1**

Machined contact pins



**SUMCP18-22AU2**

Machined contact pins



**SUMCP20-24AU1**

Machined contact pins



**SUMCP8-11AU1**

Pin contact size 8



**SUMCP8-11AU2**

Pin contact size 8



**SUMCP8-14AU1**

Pin contact size 8



**SUMCP8-14AU2**

Pin contact size 8



**SUMCP8-18AU1**

Pin contact size 8



**SUMCP8-18AU2**

Pin contact size 8



**SUMCP8-8AU1**

Pin contact size 8



**SUMCP8-8AU2**

Pin contact size 8

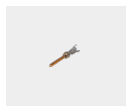

**SUPCP20-24AU2**

Pin contact punched

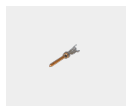

**SUPCP20-24AU2-100**

Pin contact punched, reel of 10000 pcs.

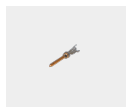

**SUPCP20-24AU2-3**

Pin contact punched, reel of 350 pcs.

**Accessory:**



**SUMCP20-24AU2**  
SUB-D contacts

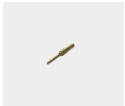

**SUMCP24-28AU1**  
SUB-D contacts

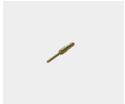

**SUMCP24-28AU2**  
SUB-D contacts