



Pin contact housing D-SUB - 9-poles

Item number: SUHV09P

Technical characteristics

Size:	1
Shell material:	Steel
Surface treatment:	Tin plated
Material contact insert:	Thermoplastic
Operation temperature:	-55°C - +105°C
Fire protection class UL94:	UL94 - V0

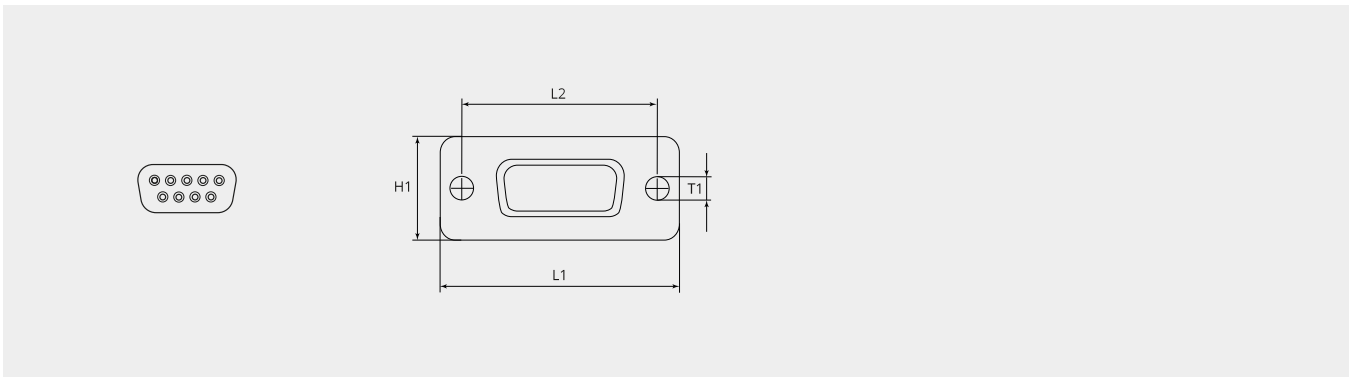

Dimensional drawing

L1 (mm):	30.8
L2 (mm):	25.0
T1 (mm):	3.0
H1 (mm):	12.5

Complementary products:

Contacts:

**SUMCP18-22AU1**

Machined contact pins

**SUMCP18-22AU2**

Machined contact pins

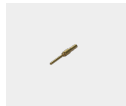
**SUMCP20-24AU1**

Machined contact pins

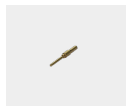
**SUMCP20-24AU2**

Machined contact pins

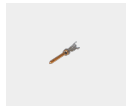
**SUPCP20-24AU2**

Pin contact punched

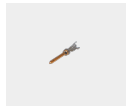
**SUPCP20-24AU2-100**

Pin contact punched, reel of 10000 pcs.

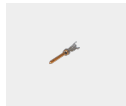
**SUPCP20-24AU2-3**

Pin contact punched, reel of 350 pcs.

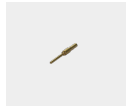
**SUMCP24-28AU1**

Machined contact pins

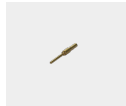
**SUMCP24-28AU2**

Machined contact pins