



Cable clamp

Cable strain relief 7-10mm, to Mega-/Gigabit modules

Item number: GMRA-CC-MG-7-10

Packing unit: 1

Technical characteristics

Shell material:	Zinc cast
Operating temperature:	-40°C - +85°C
Cable diameter (mm):	7.0 - 10.0
REACH compliant:	SVHC substances, yes - Lead
ROHS compliant:	Compliant according to 2015/863/EU (RoHS II), Annex II

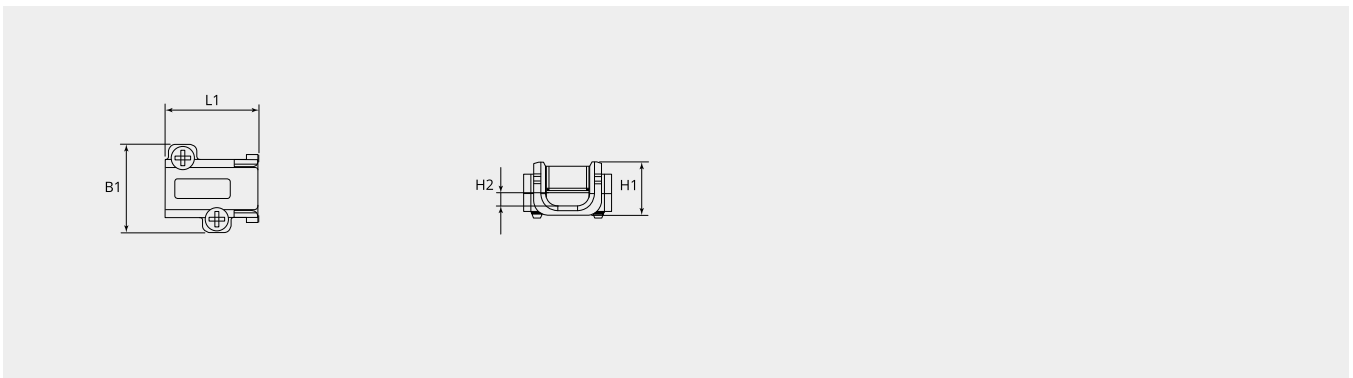

Dimensional drawing

B1 (mm):	18.1
H1 (mm):	10.9
H2 (mm):	5.1
L1 (mm):	19.2