



Hood size 24 B

1 x M25 thread, lateral, vertical

Item number: GMRH-24BS-H-SEV-1M25

Packing unit: 1

Technical characteristics

Shell material:	Aluminium die-cast
Surface treatment:	Powder-coated
Surface colour:	RAL 9005 (jet black)
Locking mode:	Screw locking
Operation temperature:	-40°C - +125°C
Material sealing ring:	Nitrile Butadiene Rubber (NBR)
Number of slots:	6 modules
Side entry vertical (SEV):	1 x M25
Cable strain relief:	Cable gland
REACH compliant:	SVHC substances, yes - Lead
ROHS compliant:	Compliant acc. to 2015/863/EU (RoHS II), Annex II

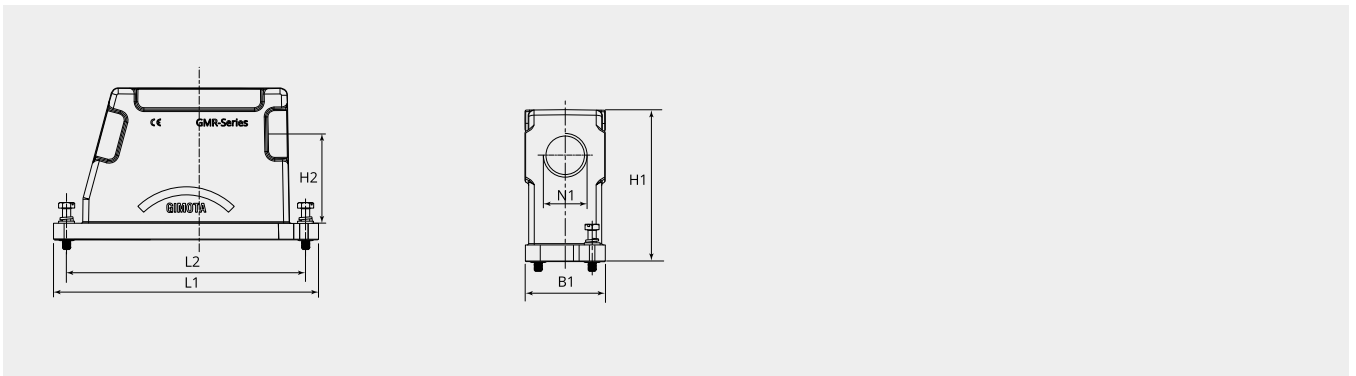

Dimensional drawing

B1 (mm):	58.0
H1 (mm):	110.0
H2 (mm):	64.8
L1 (mm):	192.0
L2 (mm):	173.0
N1:	M25x1.5



Complementary products:

Counterpart:



GMRH-24BS-BK-IF

Bulkhead mounted housing, size 24 B

Hinged frames:



GMRS-24-3-UAF-06

Hinge frame size 24

Inserts fixed pole:



GMRF-250-10-108PZC-24

Fixed pole insert 24 poles, pin, 250V, 10A



GMRF-250-10-108SZC-24

Fixed pole insert 108 poles, socket, 250V, 10A



GMRF-500-16-24PEC-24

Fixed pole insert 24 poles, pin, 500V, 16A



GMRF-500-16-24SEC-24

Fixed pole insert 24 poles, socket, 500V, 16A



GMRF-500-16-46PEC-24

Fixed pole insert 46 poles, pin, 500V, 16A



GMRF-500-16-46SEC-24

Fixed pole insert 46 poles, socket, 500V, 16A



GMRF-500-16-64PEC-24

Fixed pole insert 64 poles, pin, 500V, 16A



GMRF-500-16-64SEC-24

Fixed pole insert 64 poles, socket, 500V, 16A

Cable glands:



2900.M25N

MAXIbrass® 2900 series - M25x1.5