



Hood size 24 B

3 x M25 thread, top entry

Item number: GMRH-24BS-H-TEH-3M25

Packing unit: 1

Technical characteristics

Shell material:	Aluminium die-cast
Surface treatment:	Powder-coated
Surface colour:	RAL 9005 (jet black)
Locking mode:	Screw locking
Operation temperature:	-40°C - +125°C
Material sealing ring:	Nitrile Butadiene Rubber (NBR)
Number of slots:	6 modules
Top entry horizontal (TEH):	3 x M25
Cable strain relief:	Cable gland
REACH compliant:	SVHC substances, yes - Lead
ROHS compliant:	Compliant acc. to 2015/863/EU (RoHS II), Annex II

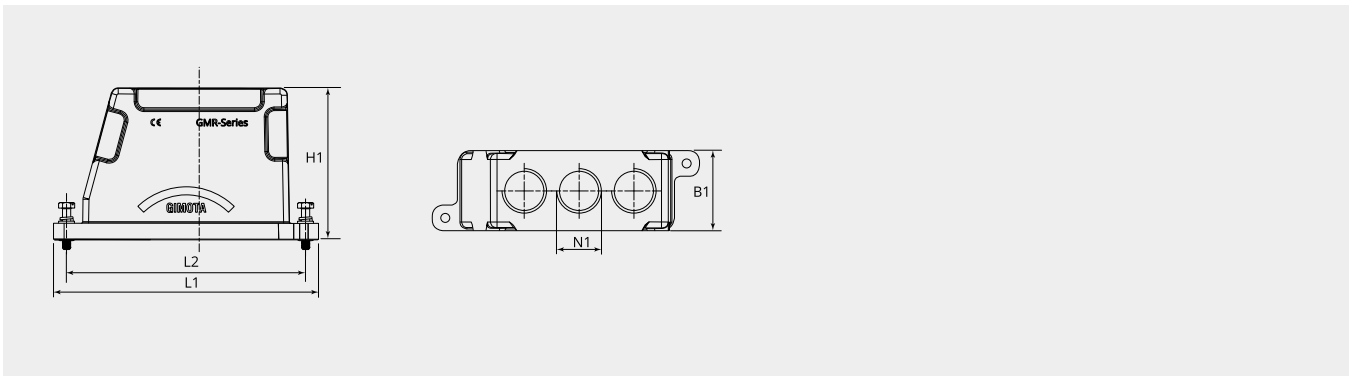

Dimensional drawing

B1 (mm):	58.0
d1 (Ø):	M25 x 1.5
H1 (mm):	110.0
L1 (mm):	192.0
L2 (mm):	173.0
N1:	M25x1.5

