



Module 6 pole, socket, 830V, 16A

Number of slots: 1

Item number: GMRM-500-16-6SEC-01

Packing unit: 1

Technical characteristics

Number of slots:	1
Number of contacts:	6
Contact type:	Socket
Number of mating cycles (min.):	500
REACH compliant:	SVHC substances, no
ROHS compliant:	Compliant

Thermal properties

Material contact insert:	Polycarbonate (PC)
Operating temperature:	-40°C - +125°C
Fire protection class UL94:	V0
Fire protection class DIN EN 45545-2:	R22/HL1,HL2 R23,24/HL1,HL2,HL3

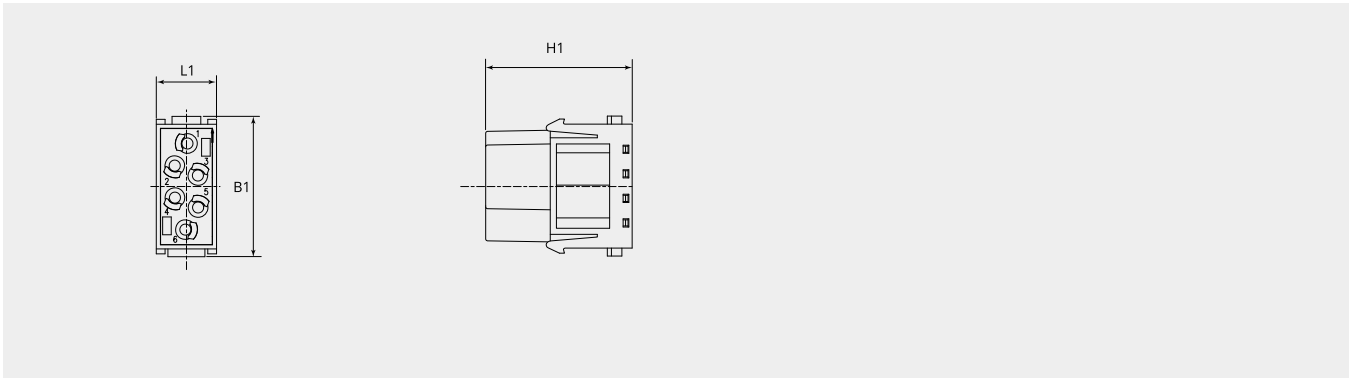

Dimensional drawing

B1 (mm):	34.2
H1 (mm):	35.8
L1 (mm):	14.6

Electrical properties

Rated current (A):	16
Operating voltage (V):	500
Rated voltage acc. to UL/CSA (V):	600
Rated impulse voltage (kV):	6
Insulation resistance (Ω):	$\geq 10^{10}$
Pollution degree:	3

