



Circular connectors for power contacts (Series GP)

Indoor, up to 4000VDC/650A, contact size HC650

Item number: GP60-36-P1SN-TAC

Packing unit: 1

Mechanical properties

Size:	36
Contact type:	Socket
Coding options:	4
Shell material:	Aluminum alloy
Surface treatment:	Epoxy-polyurethane
Type of surface:	varnished
Thickness of surface treatment:	13-16 μ
Surface colour:	black
Corrosion resistance (h):	500
Operation temperature:	-55°C - +125°C
Temperature shock:	-55°C - +125°C
Conductivity (M Ω):	non conductive
EMI:	No
Material sealing ring:	Silicone
Coupling-torque to lock (Nm):	max. 10.0
Coupling-torque to open (Nm):	min. 5.9

Thermal properties

Material contact insert:	Thermoplastic
Operating temperature:	-55°C - +150°C
Fire protection class DIN EN 45545-2:	R23/HL3
Fire protection class:	S4/SR2/ST2 / -
Fire protection class NFF16-101/102:	I3/F0 - I3-F3
Fire protection class UL94:	V0 / -

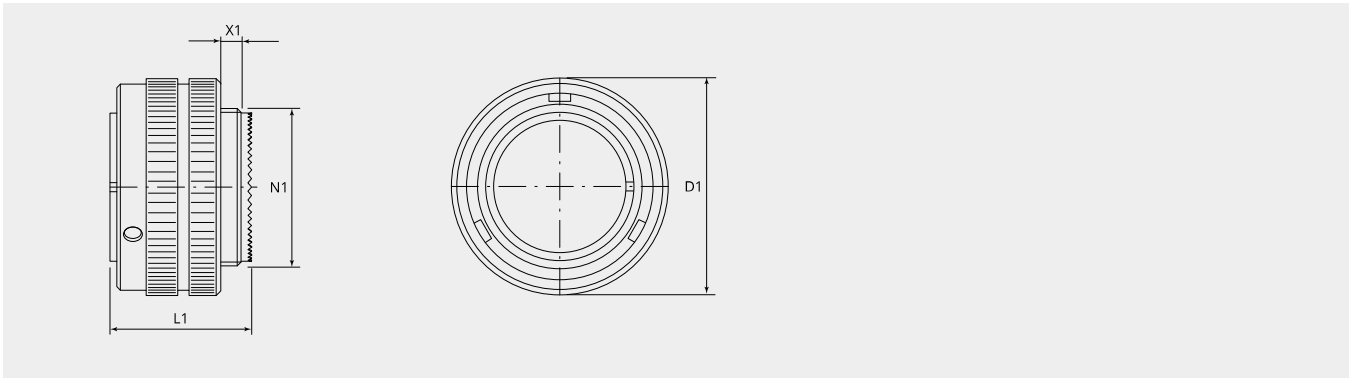

Dimensional drawing

D1 (Ø):	67.0
L1 (mm):	38.5
L2 (mm):	38.5
N1:	2 1/16"-16 UN 2A
X1 (mm):	11.3

Electrical properties

Operating voltage DC (V):	2000/4000
Insulation resistance (Ω m):	≥ 5000

Complementary products:

Counterpart:



GP321-36-P1PN-TAC
Receptacle with flange power 1pole

Contacts:



GMRC-SHC650-120AG
Socket contact HC series, 650A, 120mm²



GMRC-SHC650-150AG
Socket contact HC series, 650A, 150mm²



GMRC-SHC650-185AG
Socket contact HC series, 650A, 185mm²



GMRC-SHC650-240AG
Socket contact HC series, 650A, 240mm²



GMRC-SHC650-95AG
Socket contact HC series, 650A, 95mm²